



UNICONT

PM 300

PROGRAMMABLE CONTROLLER

PROGRAMMING MANUAL

TABLE OF CONTENTS

1.	Register	1
2.	Instruction.....	2
3.	Order Codes.....	3
4.	Accessories	3
5.	Technical Data	4
6.	Operation.....	6
7.	Installation and Wiring.....	9
8.	Control algorithms	12
9.	Programming.....	15
10.	Disabling Access.....	41
11.	Auto-Line Mode	42
12.	Error Messages	42
13.	Process Control Types.....	43
14.	Data Communication.....	48
15.	Examples.....	54

1. REGISTER

Password protection:	d.PAS.....	22
Setting value	d.nni	23
Setting decimal point	C.in1	18
Buzzer	d.HSt.....	24
Select input	C.in1	19
Display scaling assigned to the input, low value	C.i1L	17
Display scaling assigned to the input, high value	C.i1H.....	17
Low limit value	C.SuL.....	17
High limit value	C.SuH	17
Select control function	d.Cnt	23
Cycle time	d.Yt	22
Disable/Lockout	d.nni and d.Cnt.....	23
ON/OFF control, setting relay hysteresis	d.Cnt	23
ON/OFF control, setting hysteresis value	P.dZ	27
Alarm relay function	d.AL	26
Alarm relay hysteresis position	d.AHS	25
Alarm relay value	S.A	28
Alarm relay hysteresis value	S.Ah	28
Select output analogue signal	C.out	20
Display scaling assigned to the output, low value	C.o1L	17
Display scaling assigned to the output, high value	C.o1H.....	17
Linearisation	C.uSr.....	21
Differential calculation	C.nAt.....	21
Rounding	C.nAt.....	21

2. INSTRUCTION

The UNICONT PM-300 is a universal, two channel* process controller with relay and analogue outputs and PID algorithm. supporting versatile functions. It can be used from standard to extraordinary temperature control (cooling, heating) tasks. Beside the usual inputs, practically all generally used temperature sensors can be connected. Due to its auto tuning feature the controller can successfully handled by technicians unaccustomed to the process control. The dual 4-digit lighting displays allow viewing even from greater distances.

The UNICONT PM-300 is highly accurate and easy to handle, thus suitable for applications as panel instrument both in laboratory and industrial process control applications.

*(one channel for PID and the other for ON/OFF control)

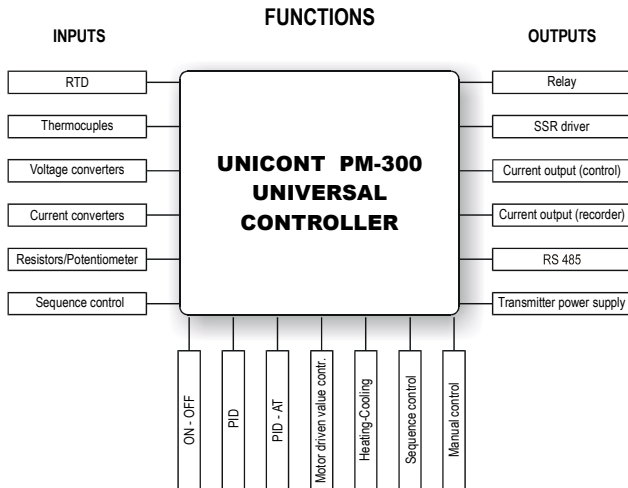

3. ORDER CODES

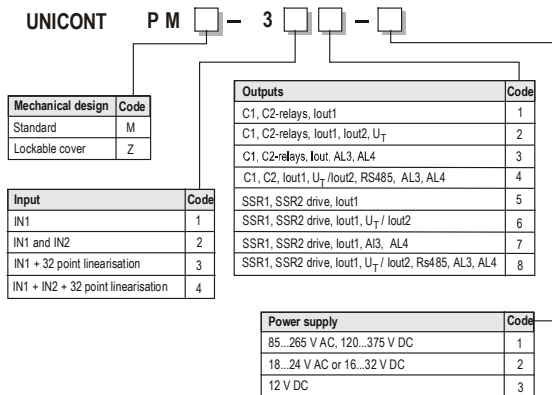

Denotation:

- IN1, IN2: Universal signal inputs
- C1/AL1, C2/A2: SPDT (Single Pole Double Throw) relay contact outputs
- AL3, AL4: SPST (Single Pole Single Throw) relay contact outputs
- SSR1, SSR2: Solid state driver output
- lout1, lout2: 4-20mA current output
- U_T: Transmitter power supply
- RS485: serial data communication interface with MODBUS protocol
- Linearisation: max. 32 point curve linearisation of input variable

4. ACCESSORIES

- 1 piece Programming and Installation Manual
- 2 pieces Mounting accessories
- 1 piece KTY83 for cold junction compensation of thermocouple
- 1 piece Resistor for shunting the input when configured for current (MR-25, 10 Ohm, 1%, 0.25 W, 2 pcs. for models with IN1 and IN2)
- 1 set Plug-in terminal blocks
- 1 piece Set of measurement unit stickers

5. TECHNICAL DATA

TYPE	SEE ORDER CODES		
Universal inputs (2)	Thermo-couple: K, J, T, E, L, U, N, R, S, B, M, A, C, RTD's: Pt 100, JPt 100, Pt 1000, JPt 1000, Cu 100, Ni 100 Current: 4-20 mA, 0-20 mA Voltage: -5+20 mV, 0-100 mV, 0-500 mV Resistance: 0-500 Ω , 0-2000 Ω		
Input resistance	Current input: 10 Ω . Voltage input >10 M Ω		
Outputs Standard version: - 2 control relays - Current output - Buzzer (Acoustic alarm) Add-ons (optional) - 2 SSR drivers - 2 Alarm relays - Second current output - Second input with diff. - Transmitter Power supp. - Data communications - 32-point linearisation	Control relays (2)	Potential free, SPDT, 250 V AC 5A (AC1)	
	Alarm relays (2)	SPST (NO or NC programmable), 30V DC/250V AC 3A (AC1)	
	SSR driver outputs (2)	12 V DC, 15 mA	
	Current outputs (2)	0/4-20 mA DC (max. load 600 ohm), galvanically isolated, short circuit protected, programmable	
	Power supply for transmitters	24V DC, 100 mA, short circuit protected	
	RS485 MODBUS	Bit rate: 600-38400 bps (programmable) Controller address: 1 to 254 (programmable)	
	Control algorithm	Features	Setting range
ON/OFF, P, PD, PI, PID (Auto-tune)	Proportional band (P)	0.0 to 409.5%	0.1%
- Cooling/heating control	Integral time (I)	0 to 4095 sec.	1 sec.
- Control valve	Derivative time (D)	0 to 4095 sec.	1 sec.
- 2 separate PID parameter sets	Cycle time (T)	0 to 255 sec.	1 sec.
- Manual valve control	Dead band	0 to 255	In PV resolution
	Hysteresis	0 to 255	In PV resolution

TYPE		SEE ORDER CODES
Display	Input signal/PV(process variable)	Upper display, red, 4 digits, 7 segments, digit height: 10 mm
	SV (Setpoint)	Lower display, green, 4 digits, 7 segments, digit height: 10 mm
	1. control output (C1)	"C1" (orange LED)
	2. control output (C2)	"C2" (orange LED)
	1...4 alarm outputs	"AL1", "AL2", "AL3", "AL4" (red LED)
	Manual Mode	"MAN" (red LED)
	PV value on the display	"PV" (red LED)
	Control function (enabled/disabled)	"RUN" (red LED)
	Setpoint SV1 active	"SV1" (green LED)
Setpoint SV2 active	"SV2" (green LED)	
Auto-tune (AT) mode	"AT" (red LED)	
Programming		Digital, by front panel keys
Accuracy of setting and displaying		$\pm 0.2\%$ FS ± 1 digit
Sensor wire-break Alarm		"Er 11" on SV display (only if the controller is on)
Cold junction compensation		Ext. temperature sensor to be connected to terminal block. The function can be disabled.
Lead resistance compensation		3 wire, automatic
Ambient moisture content		Max .85% (relative) non condensing
Ambient temperature	Operational	0°C to +55°C (+32°F to +131°F)
	Storage	-20°C to +60°C (-4 °F to +140°F)
Power supply		85...265V AC, 50/60 Hz, 8 VA and 120 V...375 V DC, 8 W or 14...28 V AC, 50/60 Hz, 8 VA or 16...32 V DC, 8 W
Electrical connections		Plug-in terminal blocks (use wires: 0.5 to 2.5 mm ² (3 x 0.0008 to 0.004 sq. inch)
Electrical protection		Class II.
Standard enclosure		Front: IP65, Rear: IP20
Mounting protection		IP54 with rubber seals ordered separately
Enclosure with lockable door		Front: IP54, Rear: IP20
Memory protection		Data stored in EEPROM
Dimensions		101.5 x 48 x 160 mm (4 x 1.92 x 6.3")
Weight		0.3 kg (0.66 pound)

6. OPERATION

The **UNICONT PM-300** Universal Controller can receive signals from transmitters, thermo-couples, RTDs, and potentiometers.

All parameters of the controller can be displayed and programmed. If error occurs, an “error message” will be shown on the “green” (PV) display.

Front panel LEDs indicate the “on status” and the operating modes of the controller, the status of the control and alarm relays and various programmed alarms. A programmed alarm can activate the controller’s own, standard built-in buzzer (alarm sound).

The **UNICONT PM-300** displays the process variable (PV) with high accuracy. Even users with little experience in process control can tune the Controller by using the “Auto-tune Mode” without need for tiresome manual setting of P, I and D parameters through several trials.

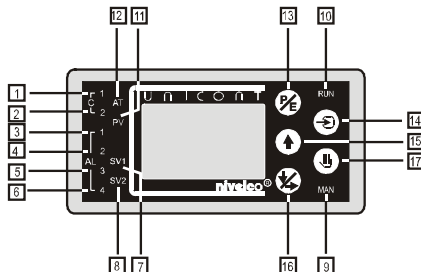

















Front panel view

On the dual-line, 4-digit display of UNICONT PM-300 both, the process variable (PV in red) and the Setpoint (SV in green) are simultaneously displayed.

Indicators LED status

- 1 — **C1**: “ON”, if Relay 1. (programmed for control) is energised
- 2 — **C2**: “ON”, if Relay 2. (programmed for control) is energised
- 3 — **AL1**: “ON”, if Relay 1. (programmed for alarm) is energised
- 4 — **AL2**: “ON”, if Relay 2. (programmed for alarm) is energised
- 5 — **AL3**: “ON”, if Alarm Relay 3. is energised
- 6 — **AL4**: “ON”, if Alarm Relay 4. is energised
- 7 — **SV1**: “ON”, if Primary Setpoint (SV1) is displayed
- 8 — **SV2**: “ON”, if Secondary (Remote) Setpoint (SV2) is displayed
- 9 — **MAN**: “ON”, if Controller is in Manual Mode, SV1 display indicates the control signal (Y) in %
- 10 — **RUN**: “OFF”, Idle Mode - The controller is disconnected from the process (the control is off)
“ON”, Run Mode - The controller is connected to the process (the control is on)
“FLASHING”, The control is performed according to the secondary (remote) Setpoint (SV2)
- 11 — **PV**: “ON”, Process Variable (PV) is shown on red (upper) display
- 12 — **AT**: “ON”, if the Controller is in the Auto-tune Mode
“FLASHING”, the auto-tune setting is not possible because the control is off.

Function of front panel keys

13		Primary function: Enter Programming Mode Menus/Submenus Secondary function: Confirm flashing values and EDS* settings (ENTER)
14		Primary function: Change over btw. Idle Mode and Run Mode (by pressing key for 5 seconds) Secondary function: Exit Menus/Submenus Acknowledge error messages: Er4, Er5, Er6, Er7
15		Primary function: Increasing the Setpoint value Scrolling Menu/Submenu points Secondary function: Increasing the displayed "flashing" value Setting the EDS* to the upper/lower position
16		Primary function: Decreasing the Setpoint value Secondary function: Decreasing the displayed flashing value Stepping from one EDS* to another
17		Primary function: Setting analogue control output (Y) to Manual Mode (press key for 15 sec) Secondary function: Resetting the latched alarms after repeated power-up
	 + 	Start/stop Auto-tune Mode (AT)
	 + 	Enable/disable access to the Definition and Calibration Tables (by pressing keys for 15 sec) -display will indicate: "SYSE" (system enabled) or "SYSd" (system disabled)
	 + 	Acknowledge error messages Er10 and Er11 as well as restart the controller
	 +  + 	Setting the Factory Default "A" Programmed for Temperature Control with PID algorithm with relay output
	 +  + 	Setting the Factory Default "B" Programmed for ON/OFF Control with relay output

* EDS: Electronic Dip Switch symbolised by 8 red light bar on the display.

Rear panel view

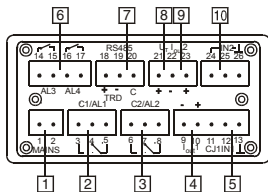

Models with relay output

- **1** — MAINS: Power supply
- **2** — C1/AL1: 1. Control/alarm relay output
- **3** — C2/AL2: 2. Control/alarm relay output
- **4** — Iout1: 1. Analogue output
- **5** — IN1: 1. Universal input

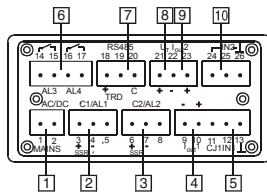

Models with SSR drive output

- **6** — AL3, AL4: 3,4. Alarm relay outputs
- **7** — RS485: RS485 interface
- **8** — U_i : Power supply for transmitters
- **9** — Iout2: 2. Analogue output
- **10** — IN2: 2. Universal input

7. INSTALLATION AND WIRING

Dimensions

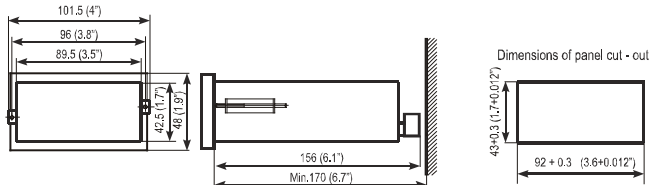

Figure 1.

Wiring

For wiring use cables of 3 x 0.5 to 2.5 mm² (3 x 0.0008 to 0.004 sq. inch)

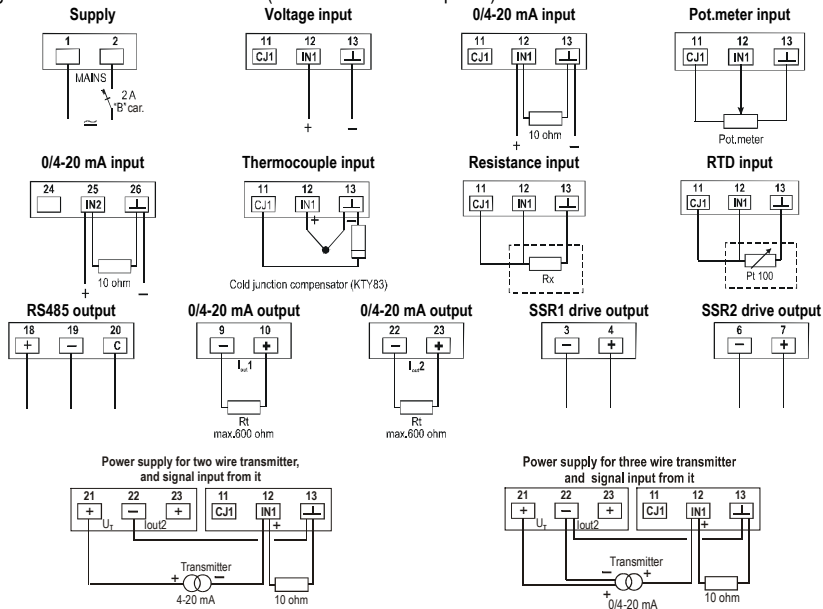

Figure 2.

Power supply (MAINS)

Connect the power supply to the **MAINS** terminals **1** and **2** with a 2-wire cable.

There is no need for protective grounding due to the dual insulation of the PM-300. For short circuit protection use a 2 A circuit breaker with "B" wire protecting characteristic. The model is internally protected by a T 315 mA fuse.

Input (IN1)

Connect the input signal (process variable "PV") as follows:

0/4-20mA current input

If the input signal is configured as a 0/4-20mA current input, connect the 10 Ohm resistor (supplied as accessory) between the terminals **12** and **13**.

Two-wire transmitters: Connect between terminals **12** and **21**.

Three-wire transmitters: Connect current output between terminals **12** and **22**
Connect (+) power supply to the terminal **21**

RTD input

RTD's are connected in a 3-wire system, using automatic wire-resistance compensation.

*If the input signal is configured as RTD input, connect the tree wires of the RTD to the terminals **11**, **12** and **13**.*

*In case of 2-wire RTD's, short-circuit the terminals **11** and **12** and use the OFFSET menu function for compensation.*

Thermocouples

If the input signal is configured as Thermocouple input, connect the Thermocouple to the terminals **12** and **13**. The KTY 83 (supplied as an accessory) for cold junction compensation should be connected between the terminals **11**, **13**.

Secondary Input (IN2)

The value of IN2 can be read-out at the menu S.in2, it can not be used for control.

Connect the secondary input signal to the terminals **25** and **26**.

For differential calculation

The secondary input can be used to calculate differential values (e.g.: two pressure transmitters for differential pressure or two level transmitters for differential level).

Remote setpoint

The secondary input is also used as a Remote Setpoint or Valve Position Feedback signal.

Current outputs (I_{OUT1} , I_{OUT2})

Transmitter output (for re-transmitting the input signal)

The input signal ($IN1$) can be assigned with or without re-scaling to any of the outputs.

Control output

In general the control signal (Y) is provided by the $C1$ relay output or by the I_{OUT1} current output.

The $C2$ relay and the I_{OUT2} current outputs are used in case of heating-cooling processes for controlling the cooling.

The Setpoint (SV) can be assigned to any of the outputs.

Contact outputs ($C1/AL1$, $C2/AL2$, $AL3$, $AL4$)

The $C1$ and $C2$ control outputs can also be programmed for alarm functions.

Alarm functions can be assigned to the $IN1$ input, Setpoint (SV) or User definable events.

The controller can be programmed for two additional alarms ("AL5", "AL6"). Their physical outputs are the current outputs used as digital signal outputs to drive external contacts.

8. CONTROL ALGORITHMS

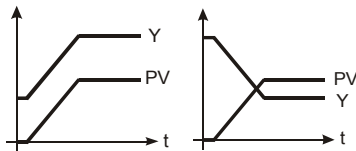

Direct algorithm

Reverse algorithm

Figure 3.

The microprocessor-based signal-processing feature makes the UNICONT PM-300 an excellent tool for a wide range of applications. It facilitates both ON-OFF and PID control applications with direct and reverse algorithm.

With direct algorithm control any increase of Process Variable (PV) will result in an increase in the output control signal (Y) (e.g.: cooling / emptying control)

With reverse algorithm control any increase of Process Variable (PV) will result in the decrease of output control signal (Y) (e.g.: heating / filling control)

ON/OFF control

It is the simplest controlling method, the output is always relay contact. The control relay will be energised or de-energised if the process variable (reference signal) goes above or below the Setpoint (SV) respectively. In order to extend the relay lifetime and avoid the chatter of the contacts a hysteresis band is assigned to the Setpoint. The hysteresis band can be symmetrical or asymmetrical. Furthermore by setting the cycle time to a value other than zero can also extend the relay lifetime.

Specify "x" in the menu P.dZ (to be set in the measuring unit of the SV)

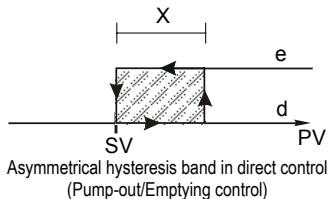
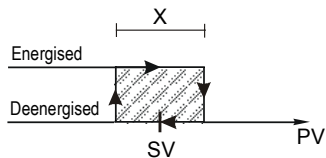
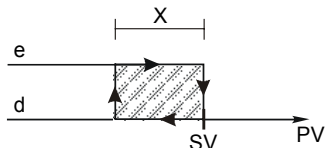
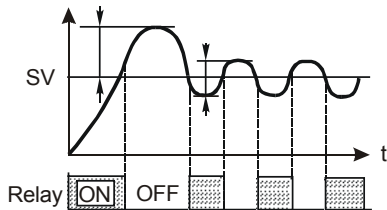

Figure 4.

PID control

The PID control mode provides more accurate control than the ON/OFF.

The PID control mode can be realised with relay contact or analogue current output. With relay contact output the PID algorithm will perform the control function by changing the energising and de-energising time within a selectable cycle time (see Figure 5). This part of the response function is called "Proportional Domain".

Proportional Band: is the domain of cyclical control mode.

Outside the Proportional Domain the control relay is permanently energised or de-energised. Cyclical control mode is effective within the Proportional Domain.

Value of Proportional Domain (p):
$$p = \frac{100}{P(\%)}$$

Where P = Proportional Gain in % entered in **P.P** and **P.cP** parameter functions

The Proportional Domain always relates to Setpoint (SV) and is positioned symmetrically to it.

*Example: If P (Proportional Gain) = 20%, then p (Proportional Domain) = 100 / 20 = 5 units
Proportional Domain: will be ± 2,5% symmetrically i.e SV=200°C means
197.5°C - 202.5°C*

Pulse Ratio: It is the pulse time per cycle time in %.

Its value depends on the control mode and the difference between the Setpoint Variable (SV) and Process Variable (PV). In case of the UNICONT PM-300, if I (Integrating Time) = 0 and D (Derivative Time) = 0, and the current value of (PV) is equal to (SV) the pulse ratio will be 50%. For PID algorithm (I ≠ 0 and D ≠ 0) these values are naturally different.

For relay output PID control the minimum (**d.YL**) and maximum (**d.YH**) of the pulse ratio should be set. Recommended values are 5% and 95% respectively.

In this case the pulse ratio is set below 5% or above 95% it will automatically change to 0% or 100% respectively

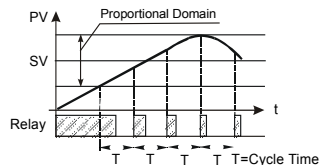

PID control with relay output

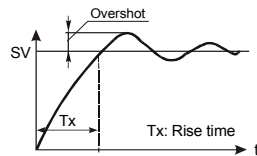

PID control with overshoot

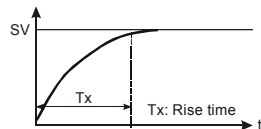

PID control without overshoot

Figure 5.



With both analogue and relay control the desired response in the process variable (PV) can be reached with or without overshoot. With overshoot the response will be achieved quicker, but sometimes the process does not endure the overshoots.

The Factory Default provides quick response and minimum overshoot (1-2%). This setting meets most requirements. For PID control without overshoot the parameter **d.trA** should be set. The default value is 50. By increasing its value the overshoot will decrease, at 80 the overshoot is practically zero. At higher values the control may involve some uncertainty, therefore each value should be checked. The Submenu point d.trA will get into the Menu (Table) by pressing the push-bottom  simultaneously with switching on the main.

9. PROGRAMMING

Operating modes

The UNICONT PM-300 has three operating modes:

- **Idle Mode:** after the first power-up, the Controller will be in Idle (Basic) Mode. Both displays (red for PV and green for SV) are active.
- **Run Mode:** the control function of the Controller is switched-on and the control outputs are active, indicated by the "RUN" LED lighting.
- **Auto-tune Mode:** the Controller automatically determines the PID settings, based upon the process characteristics. The Auto-tune Mode is indicated by the "AT" LED lighting.
 - The switch over between Idle Mode and Run Mode, press the  key for 5 seconds.
 - After repeated power-up the Controller will return to the Mode it was working in, before the power loss.
 - The Auto-tune Mode will be initiated by pressing the  and  keys simultaneously. After automatic setting of PID parameters the controller return to the RUN Mode.







Default settings

The UNICONT PM-300 has two Factory Defaults with pre-programmed parameters (for description see 8.1.).

- Factory Default A: process control oriented with PID algorithm
- Factory Default B: process indicator with limit switch

The Controller is delivered with the Factory Default A.

To change over between Factory Defaults you have to press three keys simultaneously after repeated power-up, i.e.,

- 1). Disconnect the power,
- 2). Reconnect the power and simultaneously press the following three keys simultaneously
 -  +  +  for setting Factory Default A
 -  +  +  for setting Factory Default B
- 3). Wait until the display acknowledges the change.











Programming

The programming can be initiated in all of the three operation modes.

The Controller will return to the operation mode if no keys are pressed for 30 seconds.

Name of the Menu-points	Initials of the submenu-points
Calibration Table	“C”
Definition Table	“d”
Parameter Table	“P”
Standard Table	“S”

Access to the menu/submenu-points

- To enter the Menu (Programming Mode), press the  key. (Left-side of green display will flash).
- To scroll the Menu-points, press the  or  keys. (Initial of the actual Menu-point is flashing)
- To enter the Submenu-points, press the  key. (Right-side of green display will flash).
- To scroll the Submenu-points, press the  or  keys. (Actual Submenu-point is flashing)
- To select the Submenu-point, press the  key. (Value or EDS to be set is flashing on red display).
- To set the EDS* or value, use  or  keys.
- To confirm the setting of the EDS* or value, press the  key.
- To quit Submenu-point press  key.

*Electronic Dip Switch (symbolised by 8 red light bars on the display) – Settings:

- Red bar in the upper position = “1” (ON)

- Red bar in the lower position = “0” (OFF)

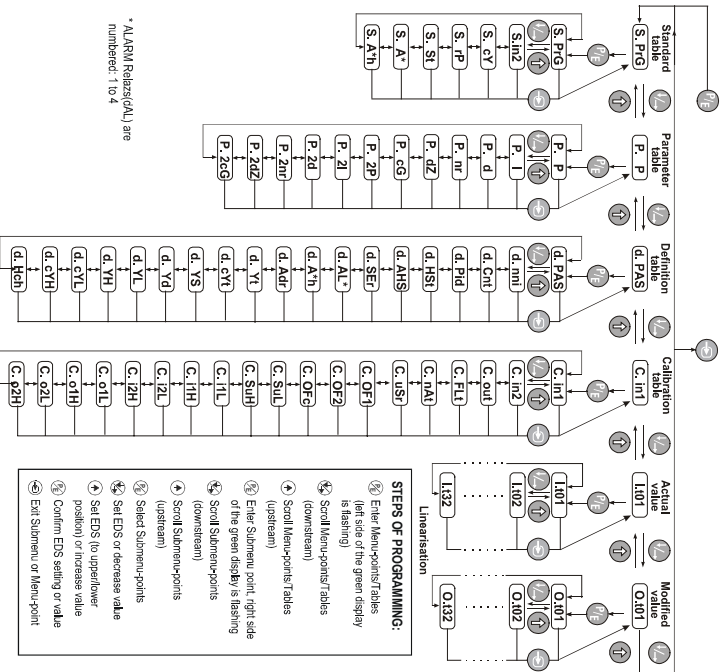

* ALARM Relays(AL) are numbered: 1 to 4

Programming flow-chart

Display during programming:

Value / submenu point



Dead zone (°C) unit

Second PID Set
"dead band"

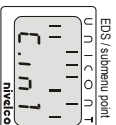

EDS / submenu point

EDS: 00111010

9.1. FACTORY DEFAULT

Factory Default “A”

The controller is pre-programmed for temperature control with PID algorithm with relay output and parameters (EDS/value) set according to the following table:



Description	Function/Value selection	Parameters
Input Decimal point	Pt 100 999.9	C.in1 : 00101110
Min. range (Low limit of measuring range)	0°C	C.SuL : 0.0
Max. range (High limit of measuring range)	200°C	C.SuH : 200.0
Control type Manual overdrive mode	Heating (relay control, reverse algorithm) Enabled	d.Cnt : 01000000
Cycle time	T= 20 sec	d.Yt = 20
Min. relay energising time, % of cycle time	0 %	d.YL = 0
Max. relay energising time, % of cycle time	100 %	d.YH = 100
Proportional gain	10 %	P.P = 10
Integrating time	90 sec	P.I = 90
Derivative time	20 sec	P.d = 20
AL2 high alarm	Absolute value of PV1	d.AL2 = 1000001
AL2 setpoint	200°C	S.A2 = 200.0
AL2 hysteresis	Assymmetric	d.AHS = 00000000
Internal buzzer (Acoustic alarm)	Enabled and assigned to AL2	d.HSt = 01010000
Current output - Range - Assigned to	4-20 mA PV signal	C.out = 00001000
4 mA value	0°C	C.o1L = 0.0
20 mA value	200°C	C.o1H = 200.0
Display settings	Roll	d.nni = 00001000

Modifying the Factory Default “A” (examples):

Application example #1:

- Heating/cooling control with ON/OFF algorithm
- Pt100 input
- Limit switching
- Re-transmitting the measured value (I_{OUT1})



Setpoint value (SV)

Set SV simply by the  and  keys on the front panel.

Measuring range

Set in the Menu-point *Calibration table*, at the Submenu-point C.SuL (min. range) and C.SuH (max. range).

PID parameters

To modify the factory set parameters of the PID algorithm, activate Auto-tune by pressing +  +  keys. simultaneously. The LED “AT” is on while Auto-tune is active.

Current output (I_{OUT1})

Set in the Menu-point *Calibration table*, at the Submenu-point C.o1L (4 mA value) C.o1H (20 mA value).

Decimal point

Set on the Menu-point *Calibration table*, at the Submenu-point C.in1.

This setting influences all values programmed previously.

Alarm (AL2)

Set the value in the Menu-point *Standard table*, at the Submenu-point S.A2.

Set the hysteresis type in the Menu-point *Definition table*, at the Submenu-point d.AHS.

Set the hysteresis value in the Menu-point *Standard table*, at the Submenu-point S.A2h.

Internal buzzer (acoustic alarm)

Set in the Menu point *Definition table*, at the Submenu-point d.HSt.

Control mode

Set the ON/OFF control mode in the *Parameter table* by setting P.P= 0, P.I= 0 and P.d= 0, at the Submenu-point S.A2 (the control mode will be: ON/OFF with (lower) asymmetrical hysteresis, and Heating control).

Set the hysteresis type of the ON/OFF control in the *Definition table*, at the Submenu-point d.Cnt.

Set the hysteresis value of the ON/OFF control in the *Parameter table*, at the Submenu-point P.dZ.

To change to Cooling control: Set in the *Definition table*, at the Submenu-point d.Cnt.

Alarm (AL1)

Set the AL1 Alarm in the *Definition table*, at the Submenu-point d.Cnt. In the Factory Default “A” the relay R1 has alarm function. The setting is the same as described above under Alarm (A2).

Input signal

Set in Menu point the *Calibration table*, at the Submenu-point C.in1.



This setting influences all values programmed previously.

In case of Thermocouples, the automatic compensation is also to set. (See C.in1).

Application example #2: Setting double comparator

- Start from Factory Default A
- Inhibit PID control P.P = 0, P.I = 0, P.d = 0
- Set cycle time d.Yt = 0
- C1 relay energised under the value set
- AL2 relay energised above the value set
- Adjust C1 according to the SV
- Adjust AL2 at Submenu points S.A2 and d.AL2

Factory Default “B”

To set the Factory Default “B” disconnect the power, then press the  +  +  keys simultaneously re-connect the power and wait until the display acknowledges the change.

The controller is pre-programmed for process indicator and limit switch (input 4-20 mA) with parameters (EDS/value) set according to the following table:

Denomination	Function/Value	EDS/Value
Input Position of the decimal point	4-20mA 999.9	C.in1 : 00111010
Scaling	4mA=0,0% 20mA=100,0%	C.i1L : 0.0 C.i1H : 100.0
Operation mode	Display, 1 input	d.Cnt : 00000001
AL1 alarm relay operation	Energised under the lower alarm value	d.AL1 : 00000001
AL1 energised over the min value	10%	S.A1 : 10.0
AL2 alarm relay operation	Energised over the upper alarm value	d.AL2 : 10000001
AL2 energised over the min value	90%	S.A2 = 90.0
Current output	4-20mA proportional to the current input	C.out : 00001000
Output value assigned to the min. input value (4 mA)	0%	C.o1L : 0.0
Output value assigned to the maxi. input value (20 mA)	100%	C.o1H : 100.0
Operation of the buzzer	in line with AL2	d.HSt : 01010000
Filtering of the input signal	medium	C.Flt : 01100000

- Set % value of energising relay AL1 at Submenu point S.A1
- Set % value of energising relay AL2 at Submenu point S.A2

-SETTING HYSTERESIS OF RELAY AL1

Set position of hysteresis (e.g. control of filling) at Submenu point d.AHS: (default parameter: 00000001)

Set value of hysteresis at Submenu point d.A1h e.g. 5%, d.A1h=5.0

- SETTING HYSTERESIS OF RELAY AL2

Set position of hysteresis (e.g. control of emptying) at Submenu point d.AHS: (default parameter: 00000000)

Set value of hysteresis at Submenu point d.A2h e.g. 5%, d.A2h=5.0

- SETTING BUZZER:

At Submenu point d-HSt. (default setting:00000000, out of work)

9.2 SUBMENU POINTS OF THE CALIBRATION TABLE

Code	Description	Limit-values	Remark
C.in1	Configuring the IN1 analogue input		See Table 2.
C.in2	Configuring the IN2 analogue input		See Table 3.
C.out	Configuring the I _{OUT1} and I _{OUT2} analogue outputs		See Table 4.
C.FLt	Setting the filtering of the IN1 and IN2 analogue inputs		See Table 5.
C.nAt	Arithmetic function and rounding		See table 6.
C.uSr	Choice of linearisation		See table 7.
C.OF1	Setting the offset of the IN1 analogue input	-1999...+1999	
C.OF2	Setting the offset of the IN2 analogue input	-1999...+1999	
C.Ofc	Setting the cold junction compensation (OFFSET)	-1999 ...+1999	
C. SuL	Setting the lower limit of measuring range (Min. range) If SV < SuL, display will be flashing	-1999 ...+9999	
C. SuH	Setting the upper limit of meas. range (Max. range) If SV > SuH, display will be flashing	-1999 ...+9999	
C.i1L	Setting the minimum value for the IN1 analogue input	-1999 ...+9999	
C.i1H	Setting the maximum value for the IN1 analogue input	-1999 ...+9999	
C.i2L	Setting the minimum value for the IN2 analogue input	-1999 ...+9999	
C.i2H	Setting the maximum value for the IN2 analogue input	-1999 ...+9999	
C.o1L	Setting the minimum value for the I _{OUT1} analogue output	-1999 ...+9999	
C.o1H	Setting the maximum value for the I _{OUT1} analogue output	-1999 ...+9999	
C.o2L	Setting the minimum value for the I _{OUT2} analogue output	-1999 ...+9999	
C.o2H	Setting the maximum value for the I _{OUT2} analogue output	-1999 ...+9999	

Notes:

- Offset setting of IN1
 This may be necessary in case of two-wired Pt100 to compensate the lack of the third wire:
 1. Short-circuit the terminals **11** and **12**.
 2. Use the Submenu point **C.OF1**. To offset the value, you may have to go through several trials while checking the 0°C (32°F) on the display using a 100 Ohm standard resistor at the place of Pt100.

- **C.out** can be configured either as a control output (Y) or to re-transmit the input signal (IN1).
 - If **C.out** is configured to re-transmit the input 0/4-20 mA signal, set 4 mA value in **C.o1L** and 20 mA value in **C.o1H**.
 - If **C.out** is configured as control output (Y), **C.o1L** and **C.o1H** must be entered in percentage, (**C.o1L** = 0% and **C.o1H** = 100% are recommended).

C.in1 Configuration of the IN1 analogue input (Table 2)

Make sure that you set decimal point (upper section of the table) and input (bottom section) as well as compensation (middle section) if applicable. (Table will continue on the next page.)

EDS	Display			
	Symbol	Lower value	Upper value	Resolution
0 0 0 0 0 0 0 0	No decimals			Place of virtual decimal point for scaleable input
0 0 1 0 0 0 0 0	999.9			
0 1 0 0 0 0 0 0	99.99			
0 1 1 0 0 0 0 0	9.999			
0 0 0 0 0 0 0 0	0°C (32°F) base compensation			
1 0 0 0 0 0 0 0	Automatic cold junction compensation			
0 0 0 0 0 0 0 0	Not used			
0 0 0 0 0 0 0 1	M	-200.0	100.0	0.1
0 0 0 0 0 0 1 0	T	-200.0	400.0	0.1
0 0 0 0 0 0 1 1	U	-200.0	600.0	0.1
0 0 0 0 0 1 0 0	L	-200.0	900.0	0.1
0 0 0 0 0 1 0 1	E	270.0	1000	0.1
0 0 0 0 0 1 1 0	J	-270.0	1200	0.1
0 0 0 0 0 1 1 1	N	-270.0	1300	0.1
0 0 0 0 1 0 0 0	K	-210.0	1372	0.1
0 0 0 0 1 0 0 1	S	-50	1760	1
0 0 0 0 1 0 1 0	R	-50	1760	1

EDS	Display			
	Symbol	Lower value	Upper value	Resolution
0 0 0 0 1 0 1 1	B	0	1820	1
0 0 0 0 1 1 0 0	A	0	2500	1
0 0 0 0 1 1 0 1	C	0	2320	1
0 0 0 0 1 1 1 0	Pt100	-200.0	850.0	0.1
0 0 0 0 1 1 1 1	JPt100	-200.0	850.0	0.1
0 0 0 1 0 0 0 0	Pt500	-200.0	850.0	0.1
0 0 0 1 0 0 0 1	JPt500	-200.0	850.0	0.1
0 0 0 1 0 0 1 0	Pt1000	-200.0	850.0	0.1
0 0 0 1 0 0 1 1	JPt1000	-200.0	850.0	0.1
0 0 0 1 0 1 0 0	Cu100	-50.0	180.0	0.1
0 0 0 1 0 1 0 1	Ni100	-60.0	250.0	0.1
0 0 0 1 0 1 1 0	KTY81	-50.0	125.0	0.1
0 0 0 1 0 1 1 1	0...500 ohm resistance	Scaleable	Scaleable	1
0 0 0 1 1 0 0 0	0...2000 ohm resistance	Scaleable	Scaleable	1
0 0 0 1 1 0 0 1	0...20.00 mA	Scaleable	Scaleable	1
0 0 0 1 1 0 1 0	4...20.00 mA	Scaleable	Scaleable	1
0 0 0 1 1 0 1 1	-5.00...20.00 mV	Scaleable	Scaleable	1
0 0 0 1 1 1 0 0	0...100 mV	Scaleable	Scaleable	1
0 0 0 1 1 1 0 1	0...500 mV	Scaleable	Scaleable	1
0 0 0 1 1 1 1 0	0...500 ohm pot. meter	Scaleable	Scaleable	1
0 0 0 1 1 1 1 1	0...2000 ohm pot.meter	Scaleable	Scaleable	1

Table 2.

*Electronic Dip Switch (symbolised by 8 red light bars on the display) – Settings:

- Red light bars in the upper position = “1” (ON)
- Red light bars in the lower position = “0” (OFF)

C.in2

Configuration of the IN2 analogue input (Table 3)

Make sure that you set decimal point (upper section of the table) and input (bottom section) as will as compensation (middle section) if applicable. (Table will continues on the next page.)

EDS	Display			
	Symbol	Lower value	Upper value	Resolution
0 0 0 0 0 0 0 0	No decimals			Place of virtual decimal for scaleable input
0 0 1 0 0 0 0 0	999.9			
0 1 0 0 0 0 0 0	99.99			
0 1 1 0 0 0 0 0	9.999			
0 0 0 0 0 0 0 0	Temperature is displayed in °C			
1 0 0 0 0 0 0 0	Temperature is displayed in °F			
0 0 0 0 0 0 0 0	Not used			
0 0 0 0 0 0 0 1	M	-200.0	100.0	0.1
0 0 0 0 0 0 1 0	T	-200.0	400.0	0.1
0 0 0 0 0 0 1 1	U	-200.0	600.0	0.1
0 0 0 0 0 1 0 0	L	-200.0	900.0	0.1
0 0 0 0 0 1 0 1	E	270.0	1000	0.1
0 0 0 0 0 1 1 0	J	-270.0	1200	0.1
0 0 0 0 0 1 1 1	N	-270.0	1300	0.1
0 0 0 0 1 0 0 0	K	-210.0	1372	0.1
0 0 0 0 1 0 0 1	S	-50	1760	1
0 0 0 0 1 0 1 0	R	-50	1760	1
0 0 0 0 1 0 1 1	B	0	1820	1
0 0 0 0 1 1 0 0	A	0	2500	1
0 0 0 0 1 1 0 1	C	0	2320	1
0 0 0 0 1 1 1 0	Pt100	-200.0	850.0	0.1

EDS	Display			
	Symbol	Lower value	Upper value	Resolution
0 0 0 0 1 1 1 1	JPt100	-200.0	850.0	0.1
0 0 0 1 0 0 0 0	Pt500	-200.0	850.0	0.1
0 0 0 1 0 0 0 1	JPt500	-200.0	850.0	0.1
0 0 0 1 0 0 1 0	Pt1000	-200.0	850.0	0.1
0 0 0 1 0 0 1 1	JPt1000	-200.0	850.0	0.1
0 0 0 1 0 1 0 0	Cu100	-50.0	180.0	0.1
0 0 0 1 0 1 0 1	Ni100	-60.0	250.0	0.1
0 0 0 1 0 1 1 0	KTY81	-50.0	125.0	0.1
0 0 0 1 0 1 1 1	0...500 Ohm resistance	Scaleable	Scaleable	1
0 0 0 1 1 0 0 0	0...2000 Ohm resistance	Scaleable	Scaleable	1
0 0 0 1 1 0 0 1	0...20.00 mA	Scaleable	Scaleable	1
0 0 0 1 1 0 1 0	4...20.00 mA	Scaleable	Scaleable	1
0 0 0 1 1 0 1 1	-5.00...20.00 mV	Scaleable	Scaleable	1
0 0 0 1 1 1 0 0	0...100 mV	Scaleable	Scaleable	1
0 0 0 1 1 1 0 1	0...500 mV	Scaleable	Scaleable	1
0 0 0 1 1 1 1 0	0...500 Ohm pot.meter	Scaleable	Scaleable	1
0 0 0 1 1 1 1 1	0...2000 Ohm pot.meter	Scaleable	Scaleable	1

Table 3.

Notes:

- The selectable °C/°F indication will apply to both IN1 and IN2.
- The automatic cold junction compensation set for IN1 applies to IN2 as well.
If the signal to IN1 does not come from a temperature sensor, there will be no cold junction, or wire compensation for IN2 either. In this case the compensation can be done by the OFFSET function.
- In case of setting follow-up control (at d.Cnt) the decimal point set at C.in1 will automatically set for C.in2.

C.out Configuring of the analogue outputs I_{OUT1} and I_{OUT2}

Make sure that in case of two outputs you configure both of them.

EDS	Description		Remark
0 0 0 0 0 0 0 0	Range of I _{OUT1} : 0-20 mA	Range	Configuring of analogue output signal I _{OUT1}
0 0 0 0 1 0 0 0	Range of I _{OUT1} : 4-20 mA		
0 0 0 0 0 0 0 0	I _{OUT1} proportional to IN1	Features	
0 0 0 0 0 0 0 1	I _{OUT1} proportional to IN2		
0 0 0 0 0 0 1 0	I _{OUT1} proportional to SV (control output)		
0 0 0 0 0 1 0 0	I _{OUT1} is the control output Y1 (heating)		
0 0 0 0 0 1 0 1	I _{OUT1} is the control output cY2 (cooling)		
0 0 0 0 0 1 1 0	Signal from AL1 alarm relay, energised status: I _{OUT1} = 20mA		
0 0 0 0 0 1 1 1	Signal from AL5 alarm relay, energised status: I _{OUT1} = 20mA		
0 0 0 0 0 0 0 0	Range of I _{OUT2} : 0-20 mA		
1 0 0 0 0 0 0 0	Range of I _{OUT2} : 4-20 mA		
0 0 0 0 0 0 0 0	I _{OUT2} proportional to IN1	Features	
0 0 0 1 0 0 0 0	I _{OUT2} proportional to IN2		
0 0 1 0 0 0 0 0	I _{OUT2} proportional to SV (control output)		
0 1 0 0 0 0 0 0	I _{OUT2} is the control output Y1 (heating)		
0 1 0 1 0 0 0 0	I _{OUT2} is the control output cY2 (cooling)		
0 1 1 0 0 0 0 0	Signal from AL2 alarm relay, energised status: I _{OUT2} = 20mA		
0 1 1 1 0 0 0 0	Signal from AL6 alarm relay, energised status: I _{OUT2} = 20mA		

Table 4.

Notes:

Set both range as well as features of I_{OUT}

- In heating-cooling control applications I_{OUT1} is the heating (Y) and I_{OUT2} is the cooling (cY) control signal.
- Although the Relay 1. and 2 are configured for control (C1, C2), their internal, free programmable relays can be used as bistable alarm relays (AL1, AL2).
- The same applies for AL5 and AL6 De-energised status: 0/4 mA, Energised Status: 20 mA

C.Flt Setting the filtering of In1 and In2 input signals

EDS	Description	Remark
0 0 0 0 0 0 0 0	No filtering A/D conversion optimised to mains for 50 Hz	
1 0 0 0 0 0 0 0	A/D conversion optimised to mains for 60 Hz	
0 0 1 1 0 0 0 0	Recommended value*	
0 1 1 1 1 1 1 1	The strongest (longest) filtering time (approx. 50-70 sec)	

Table 5.

* If you are uncertain which filtering to use select this option.

C.nAt Setting of arithmetic function and rounding

EDS	Description	Remark
0 0 0 0 0 0 0 0	No arithmetic function and rounding	
1 0 0 0 0 0 0 0	Summarising function (Result value on PV display)	PV=IN1+IN2
1 1 0 0 0 0 0 0	Summarising function (Result value on PV2 at Submenupoint S.in2)	PV2=IN1+IN2
1 0 1 0 0 0 0 0	Differential function (IN1-IN2)	PV= IN1 - IN2
1 0 0 1 0 0 0 0	Differential function (IN2-IN1)	PV= IN2 - IN1
1 0 0 0 1 0 0 0	Average function (IN1+IN2)/2	PV= (IN1+IN2)/2
0 0 0 0 0 0 0 0	No rounding	Not depending on the decimal point
0 0 0 0 0 0 0 1	Rounding the last digit to even number	
0 0 0 0 0 0 1 0	Rounding the last digit to 0 or 5	
0 0 0 0 0 1 0 0	Rounding the last two digits to 20-40-60-80	
0 0 0 0 0 1 0 1	Rounding the last two digits to a number dividable by 25	
0 0 0 0 0 1 1 0	Rounding the last two digits to a number dividable by 50	
0 0 0 0 0 1 1 1	Rounding the last two digits to 00	

Table 6.

Notes:

- Set arithmetic function according upper and rounding lower part of the table
- The arithmetic function works only in instruments with the second output (IN2), see order codes.
- The rounding effects the PV display by applying the standard rules of rounding.

EDS	Description	Remark
0 0 0 0 0 0 0 0	No linearisation	No message on the display
1 0 0 0 0 0 0 0	Linearisation operational	
1 1 0 0 0 0 0 0	Linearisation change the aggregate value of IN1 and IN2	Display according to C.nAt
1 0 1 0 0 0 0 0	Linearisation change the scaled value of IN2	Display at the menu function S.in2
1 0 0 1 0 0 0 0	Linearisation change the scaled value of IN1	Message on the PV display
0 0 0 0 0 1 0 0	The change of the second PID parameter set permitted	According to AL6
0 0 0 0 0 0 1 0	PID parameters will slowly be defined in Auto tuning function	Overshooting decreases
0 0 0 0 0 0 0 1	Cable compensation at RTD input is cut off	
0 0 0 0 1 0 0 0	Operation is determined by AL5	AL5 (energised) Only manual control possible

Table 7.

Notes:

- Linearisation is only in instruments with suitable hardware configuration applicable (see order codes).
- Creation of the second PID parameter set: the change of the parameter set depends on the state of relay Alarm 6. i.e. in the de-energised state is the original parameter set, while energised the second parameter set (P.2P, P.2I, P.2d, P.2DZ, p.2cG) is valid. The change of the parameter set is independent from the existence of the relay. The second parameter set can not be used unless the change is enabled. The controller will store the results of the AT (auto-tuning) in the chosen parameter set.
- The parameters of the controlled adjustment may change depending on the process value. To provide optimal accuracy and velocity of the control process a second PID parameter set may be needed.
- In the case of control with an accuracy of 0,1 degree the cable compensation causes an uncertainty of $\pm 0,1$ degree that reduce the accuracy. In applications with short connection cables and small resistance or in 2-wire applications where the cable compensation does not make sense, the automatic cable compensation may be cut off.

9.3 SUBMENU-POINTS OF THE DEFINITIONS TABLE

Code	Description	Limits	Remark
d.PAS	Access code (4-digits). When set, the Calibration and Definition Tables can not be accessed. "0000" means there is no access code. Flashing "9999" indicates a valid access code.	0001...8091	
d.nni	Front panel functions	See Table	Table 8.
d.Cnt	Process control functions	See Table	Table 9.
d.Pid	Process control parameters	See Table	Table 10.
d.HSt	Internal buzzer (acoustic alarm)	See Table	Table 11.
d.AHS	Hysteresis type alarms relays	See Table	Table 12.
d. SEr	Serial data communication	See Table	Table 13.
d. AL*	Alarms	See Table	Table 14. -17
d.A*h	Hysteresis value of alarm relays	0.0...255	
d.Adr	Controller address for serial data communication: 1...254: Slave Mode 255, or 0: No communication	0...255	
d.Yt	Cycle time/valve actuating time for relay C1	0...255 sec.	
d.cYt	Cycle time/valve actuating time for relay C2	0...255 sec.	
d.YS	Initial value of analogue valve control signal. (Effective according to the programming)	0...100%	
d.Yd	Dead band for the output signal, i.e: no change at the output signal within the dead band. (Used for motor driven valve control)	0...100%	
d.YL	Minimum value of I_{OUT1}	0...100%	
d.YH	Maximum value of I_{OUT1}	0...100%	
d.cYL	Minimum value of I_{OUT2}	0...100%	
d.cYH	Maximum value of I_{OUT2}	0...100%	
d.Hch	Extent of hysteresis in the heating/cooling process control		Eng. Unit if the PV

* Serial number of the alarm relays (AL1, AL2, AL3 and AL4), depending on the ordered configuration.

See notes to this table on next page

Notes:

- To enable/disable access to the Definition Table, press keys ⏏ + P/E for more than 15 seconds. SYS.E and soon after SYS.d (disabled) is displayed. Enabling access will be performed similarly.
- In case of a relay control, irrespective of the chosen control algorithm, it is always the C1 relay that is configured as the relay control output.

Exceptions:

1. Heating-cooling control
C1 (with reverse algorithm) is used for heating and C2 (with direct algorithm) is used for cooling
 2. Motor driven valve control
C1 is used for opening and C2 is used for closing the valve.
- The percentage value set in **d.YS** will be effective, if:
 - either the changing to Manual Mode (according to menu function **d.Cnt**) is done with this value
 - or at switching the power supply on (according to menu function **d.Pid**) the valve, starts at a percentage value defined by **d.YS** instead of 0%.
 - The full opening/closing of the valve can be avoided by setting minimum (**d.YL**) and maximum (**d.YH**) limiting values for the analogue output current. Thus the full closing and opening of the valve can be avoided. Enabling may be set at the menu function **d.Pid**.

d.nni Front panel functions

EDS	Description	Remark
1 0 0 0 0 0 0 0	Disable access to front panel setting of SV1	
0 0 0 0 0 0 0 1	Enable setting of Alarm Relay hysteresis	
0 1 0 0 0 0 0 0	Disable access to Standard Table	Disable Definition Table too
0 0 1 0 0 0 0 0	Disable the access to Parameter Table	
0 0 0 1 0 0 0 0	Disable Auto-Tuning Mode (AT)	
0 0 0 0 0 0 0 0	Display set by digits (each digit is scrolled individually)	
0 0 0 0 1 0 0 0	Display set continuously (the complete display value is scrolled)	"Roll-over"
0 0 0 0 0 1 0 0	After power failure the PM-300 goes to Idle Mode	Error code Er5
0 0 0 0 0 0 1 0	If the Setpoint is changed while control is in progress, control will be switched off with error code Er6	Holds last Setpoint

Table 8.

d. Cnt Process control functions



EDS	Description	Remark
0 0 0 0 0 0 0 0	Relay control (C1) with reverse algorithm for heating control	C1 energised, if $PV < SV$
0 0 0 0 0 0 0 1	l _{OUT1} with reverse algorithm for heating or filling control	C1 and C2 function as alarm relays
0 0 0 0 0 0 1 0	Relay control for cooling (C2) / heating (C1) with 2 PID loops	Dead band should be set
0 0 0 0 0 0 1 1	Relay control for motor driven valves (C1 and C2 activ)	C2 interlocks C1
0 0 0 0 0 1 0 0	Relay control (C1) with direct algorithm for cooling control	C1 energised, if $PV > SV$
0 0 0 0 0 1 0 1	l _{OUT1} with direct algorithm for cooling or emptying control	C1 and C2 function as alarm relays
0 0 0 0 0 1 1 0	Analogue control for cooling / heating with PID loop. l _{OUT1} l _{OUT2} perform the control	C1 and C2 function as alarm relays
0 0 0 0 0 0 0 0	ON/OFF control (C1), with symmetric relay hysteresis (P=0, I=0 and D=0)	
0 0 0 0 1 0 0 0	ON/OFF control (C1), with asymmetric relay hysteresis (P=0, I=0 and D=0) for heating or filling	
0 0 0 0 1 1 0 0	ON/OFF control (C1), with asymmetric relay hysteresis (P=0, I=0 and D=0) for cooling or emptying	
0 0 0 0 0 0 0 0	Control according to SV1 set on front panel	SV1, constant value control
0 0 0 1 0 0 0 0	Control according to IN2 analogue Setpoint value (SV2) (follow-up control, double display)	SV2 displayed in green
0 0 1 1 0 0 0 0	Control according to programmed Setpoint Ramp Rate and Setpoint Holding Time	
0 0 0 0 0 0 0 0	Manual Mode disabled. In case of error, Idle Mode is activated	Error: failure in sensor circuit, Er11, Er12
0 1 0 0 0 0 0 0	Manual Mode enabled	On the elimination of the fault, control will continue
1 0 0 0 0 0 0 0	In case of error, Manual Mode is activated with the last value of Y on hold	To reset, press (Ⓜ) for 10 sec
1 1 0 0 0 0 0 0	In case of error, Manual Mode is activated with the value set in "d.YS"	

Table 9.

d.Pid Process control parameters

EDS	Description
0 0 0 0 0 0 0 1	Reset latched Alarm. returns to "0" after activated
0 0 0 0 0 0 0 0	Sample rate of Ramp Rate Alarms set to 10 sec
0 0 0 0 0 0 1 0	Sample rate of Ramp Rate Alarms set to 100 sec
0 0 0 0 0 1 0 0	Set the control signal to the maximum value d.YS in accordance with AL5
0 0 0 0 0 0 0 0	If control signal $Y < d.YL$ or $Y > d.YH$, it will be replaced by 0% or 100% respectively Set min. and max. values at menu functions: d.YL, d.YH, d.cYH, d.cYL
0 0 0 0 1 0 0 0	If control signal $Y < d.YL$ or $Y > d.YH_{max}$, it will be replaced by the value in d.YL, d.YH, d.cYH, d.cYL resp. In case of analogue control, positions of the motor driven valve can be limited to values set in: d.YL, d.YH, , d.cYL, d.cYH
0 0 0 0 0 0 0 0	Start of PID is "bumpless". Upon switching the power supply on the Setpoint ramps from 0.0%
0 0 0 1 0 0 0 0	Upon switching the power supply on, the PID starts from a value set in d.YS
0 0 0 0 0 0 0 0	No derivative filtering
0 0 1 0 0 0 0 0	Low derivative filtering
0 1 0 0 0 0 0 0	Medium derivative filtering (recommended)
0 1 1 0 0 0 0 0	High derivative filtering
0 0 0 0 0 0 0 0	Derivative sampling rate set to 5 sec
1 0 0 0 0 0 0 0	Derivative sampling rate set to 10 sec

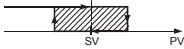
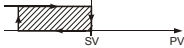
Table 10.

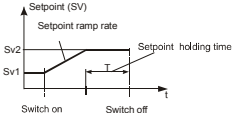
Note:

With relay output PID control, the pulse ratio decreases continuously. Below **d.YL** and **d.cYL**, and above **d.YH** and **d.cYH** there is no pulsing, the relay will be energised or de-energised permanently.

d.HSt

Internal buzzer (acoustic alarm)

EDS	Description	Remark
0 0 0 0 0 0 0 0	Buzzer is disabled	
0 1 0 0 0 0 0 0	Buzzer operates simultaneously with AL1	
0 1 0 1 0 0 0 0	Buzzer operates simultaneously with AL2	
0 1 1 0 0 0 0 0	Buzzer operates simultaneously with AL3	
0 1 1 1 0 0 0 0	Buzzer operates simultaneously with AL4	
0 0 0 0 0 0 0 1	AL1 will be triggered after PV reaches SV1 the first time	
0 0 0 0 0 0 1 0	AL2 will be triggered after PV reaches SV1 the first time	
0 0 0 0 0 1 0 0	AL3 will be triggered after PV reaches SV1 the first time	
0 0 0 0 1 0 0 0	AL4 will be triggered after PV reaches SV1 the first time	
1 0 0 0 0 0 0 0	Buzzer will operate inverse to AL	

Table 11.

d.AHS

Hysteresis type alarms relays

EDS	Description	Remark
0 0 0 0 0 0 0 0	AL1 hysteresis is lower asymmetrical (Filling control)	
0 0 0 0 0 0 0 1	AL1 hysteresis is upper asymmetrical (Emptying control)	
0 0 0 0 0 0 1 0	AL1 hysteresis is symmetrical	
0 0 0 0 0 0 0 0	AL2 hysteresis is lower asymmetrical (Filling control)	
0 0 0 0 0 1 0 0	AL2 hysteresis is upper asymmetrical (Emptying control)	
0 0 0 0 1 0 0 0	AL2 hysteresis is symmetrical	
0 0 0 0 0 0 0 0	AL3 hysteresis is lower asymmetrical (Filling control)	
0 0 1 1 0 0 0 0	AL3 hysteresis is upper asymmetrical (Emptying control)	
0 0 1 0 0 0 0 0	AL3 hysteresis is symmetrical	
0 0 0 0 0 0 0 0	AL4 hysteresis is lower asymmetrical (Filling control)	
0 1 0 0 0 0 0 0	AL4 hysteresis is upper asymmetrical (Emptying control)	
1 0 0 0 0 0 0 0	AL4 hysteresis is symmetrical	

Table 12.

Note:

The hysteresis of the relays AL5 and AL6 is always symmetric. Setting hysteresis in **S.A*h**.

d.SEr

Serial data communication

EDS	Description
0 0 0 0 0 0 0 0	Communication interface disabled
0 0 0 0 0 0 0 1	600 bps
0 0 0 0 0 0 1 0	1200 bps
0 0 0 0 0 0 1 1	2400 bps
0 0 0 0 0 1 0 0	4800 bps
0 0 0 0 0 1 0 1	9600 bps
0 0 0 0 0 1 1 0	19200 bps
0 0 0 0 0 1 1 1	38400 bps
0 0 0 0 0 0 0 0	EVEN parity, (2 STOP bits in case CF/Seri/[4]=0)
0 0 0 0 1 0 0 0	ODD parity
0 0 0 0 0 0 0 0	Transfer without parity check
0 0 0 1 0 0 0 0	Transfer with parity check
0 0 0 0 0 0 0 0	7 bit data communication (ASCII)
0 0 1 0 0 0 0 0	8 bit data communication (RTU)
0 1 0 0 0 0 0 0	NA
1 0 0 0 0 0 0 0	"Broadcast" command enabled

Table 13.

EDS	Description	Remark
0 0 0 0 0 0 0 0	No alarm function	
1 0 0 0 0 0 0 1	HIGH Alarm (Relay: NO) Alarm is triggered if the IN1 input signal (absolute value of PV1) exceeds upper limit value	
0 0 0 0 0 0 0 1	LOW Alarm (Relay: NC) Alarm is triggered if the IN1 input signal (absolute value of PV1) exceeds lower limit value	
1 0 0 0 0 0 1 0	HIGH Alarm (Relay: NO) Alarm is triggered if PV2 value exceeds upper limit value	
0 0 0 0 0 0 1 0	LOW Alarm (Relay: NC) Alarm is triggered if PV2 value exceeds lower limit value	
1 0 0 0 0 0 1 1	HIGH alarm (Relay: NO) Alarm is triggered if SV value exceeds upper limit value	
0 0 0 0 0 0 1 1	LOW alarm (Relay: NC) Alarm is triggered if SV value exceeds lower limit value	
1 0 0 0 0 1 0 1	HIGH alarm (Relay: NC) Alarm is triggered if Y output value exceeds upper limit value	
0 0 0 0 0 1 0 1	LOW alarm (Relay: NO) Alarm is triggered if Y output value exceeds lower limit value	
1 0 0 0 0 1 1 0	HIGH alarm (Relay: NC) Alarm is triggered if cY output signal exceeding the upper limit	
0 0 0 0 0 1 1 0	LOW alarm (Relay: NO) Alarm is triggered if cY output signal exceeding the lower limit	
1 0 0 0 1 0 0 1	HIGH alarm (Relay: NC) Alarm is triggered if PV value exceeds the upper limit of Setpoint (SV) with a specified value, $AL=SV + X$	
0 0 0 0 1 0 0 1	LOW alarm (Relay: NO) Alarm is triggered if PV value exceeds the lower limit of Setpoint (SV) with a specified value, $AL=SV - X$	
0 0 0 0 1 0 1 1	WINDOW comparator, "inside window" alarm Alarm is triggered if PV1 is inside the band bordered by AL*	
1 0 0 0 1 0 1 1	WINDOW comparator, "outside window" alarm Alarm is triggered if PV1 is outside the band bordered by AL*	
0 0 0 0 1 1 0 1	Alarm for Ramp Rate of PV1	Can be set in d.AL*
0 0 0 0 1 1 1 0	Alarm for Ramp Rate of PV2	Can be set in d.AL*
0 0 0 0 0 0 0 0	Alarm function iif set as aboves always active	
0 0 1 0 0 0 0 0	Relay latching. Undo by manual reset only	Reset by front panel pushbutton, See d.Pid
0 1 0 0 0 0 0 0	After switching off the controller relay return to its idle position	

Table 14.

- Serial number of the alarm relays (dAI* means AL1, AL2, AL3 AL4, AL5 and AL6), depending on the ordered configuration.
- Value of X may be set in **S.A***

d.AL* Alarms (event related)

EDS	Description	Remark
0 0 0 0 1 1 1 1	Alarm is activated upon switching on the RUN Mode	
0 0 0 1 0 0 0 0	Alarm is activated during AT (auto-tune) is in progress	
0 0 0 1 0 0 1 0	Alarm is activated during the Manual Mode	
0 0 0 1 0 0 1 1	Alarm is activated during Error	
0 0 0 1 0 1 0 0	Alarm is activated during Data communication	
0 0 0 1 0 1 0 1	Alarm is activated during the RAMP status (monitoring the Ramp Rate)	In case of programmed control
0 0 0 1 0 1 1 0	Alarm is activated during the SOAK status (monitoring the Setpoint Holding Time)	In case of programmed control

Table 15.

- Serial number of the alarm relays (dAI* means AL1, AL2, AL3 AL4, AL5 and AL6), depending on the ordered configuration.

d.AL* Alarms (Logical relation)

EDS	Description	Remark
0 0 0 1 0 1 1 1	AL1 OR AL2	
0 0 0 1 1 0 0 0	AL1 AND AL2	
0 0 0 1 1 0 0 1	AL1 XOR AL2	
0 0 0 1 1 0 1 0	AL3 OR AL4	
0 0 0 1 1 0 1 1	AL3 AND AL4	
0 0 0 1 1 1 0 0	AL3 XOR AL4	

Table 16.

- Serial number of the alarm relays (dAI* means AL1, AL2, AL3 AL4, AL5 and AL6), depending on the ordered configuration.

d.AL* Logical functions

ALARM1 ALARM3 ALARM5	ALARM2 ALARM4 ALARM6	AND	OR	XOR
0	0	0	0	0
0	1	0	1	1
1	0	0	1	1
1	1	1	1	0

Table 17.

- Serial number of the alarm relays (dAI* means AL1, AL2, AL3 AL4, AL5 and AL6), depending on the ordered configuration.

9.4 SUBMENU-POINTS OF THE PARAMETER TABLE

Code	Description	Range	Remark
P.P	First PID set: Proportional Gain (P) of first control loop [%]	0...409.5	
P.I	First PID set: Integral Time (I) of first control loop [sec]	0...4095	
P.d	First PID set: Derivative Time (D) of first control loop [sec]	0...4095	
P.nr	First PID set: "Manual reset" value of first control loop. (The Setpoint is virtually offset by this value)	-1999...+1999	Active if P.I = 0
P.dZ	First PID set: "Dead band" for heating-cooling control or motor driven valve applications. Hysteresis value for ON-Off control (P.P=0, P.I=0, P.d=0)	0...255	
P.cG	First PID set: Power Ratio* of the control device	0,1...100	
P.2P	Second PID set: Proportional Gain (P) of first control loop [%]	0.0...409.5	
P.2I	Second PID set: Integral Time (I) of second control loop [sec]	0...4095	
P.2d	Second PID set: Derivative Time (D) of second control loop [sec]	0...4095	
P.2nr	Second PID set: "Manual reset" value of second control loop.	-1999...+1999	
P.2dZ	Second PID set: "Dead band"	-1999...+1999	
P.2cG	Second PID set: Power Ratio	0,1...100	

Note:

* Efficient power ratio of the heating-cooling control devices.

Notes:

- There are two sets of PID parameters available for setting but only one of them is operable (either Set 1 or Set 2)
- Using AT (auto-tune) the P, D and I parameters are automatically set.

9.5 SUBMENU-POINTS OF THE STANDARD TABLE

Code	Description	Range	Remark
S.PrG	Software revision number		
S.in2	Value of second input (In2)		Read only
S.cY	Output signal value of the second control loop for heating-cooling control. Can be changed only in Manual Mode	0...100%	
S.rP	Ramp Rate value in Ramp Rate control	-1999...+9999	unit/hour
S.St	"Holding Time" of Setpoint after the Setpoint is reached. If the operator try to change the Setpoint during holding time the result (will be according to the last two rows of "d.nni" see page 22) - either error signal "Er6", - or control according to the changed Setpoint	0...4095	Minute
S.A*	Alarm values	Based on PV	
S.A*h	Alarm hysteresis	0...255	

* Serial number of the alarm relays (AL1, AL2, AL3, AL4, AL5 and AL6), depending on the ordered configuration.

Notes:

- The hysteresis values of alarms can also be set in the Menu point *Definition Table*.
- The signal value of the second input (IN2) can be read-out in Submenu point "**S.in2**" e.g. in motor driven valve control, if the position-detecting potentiometer is connected to IN2, the valve position can be read-out in the Submenu point "**S.in2**".

10. DISABLING ACCESS

Access for programming the UNICONT PM-300 can be enabled/disabled:

- by an access code,
- by setting the Submenu point “**d.nni**” in the Menu point *Definition Table*
- via front panel keys

a). Access lock with access code

The access code can be set between 0001 and 8091 in the Submenu “**d.PAS**” at the *Definition Table*.

If access is disabled by an access code, programming of the *Definition* and *Calibration Tables* is denied, however it does not affect the access to the *Parameter and Standard Tables*.

If access is disabled by an access code, “9999” will be displayed at the Submenu point “**d.PAS**”.



To enable access, the value “9999” must be overwritten by the access code.

To delete the access code, after entering the access code, “0000” must be entered.



b). Access locks set in the Submenu point “d.nni”

EDS	Description	Remark
1 0 0 0 0 0 0 0	Disable settings of SV1 by front panel keys	
0 0 0 0 0 0 0 1	Disable settings of the alarm relay's hysteresis	
0 1 0 0 0 0 0 0	Disable settings of the Standard Table	Disabling the Definition Table also required
0 0 1 0 0 0 0 0	Disable settings of the Parameter Table	
0 0 0 1 0 0 0 0	Disable settings of Auto-Tune function	

c). Access lock set by the front panel keys

To enable/disable access to the Definition Table, press the  and  keys for 15 seconds.

11. AUTO-LINE MODE

- 1). Set the UNICONT PM-300 to RUN Mode (after it has been programmed)
- 2). Press the  +  keys to set the AT Mode.

In AT Mode the Controller starts from the initial position, then - after three “forced” overshots - it will return to the programmed Setpoint. The size of the “forced” overshots may be as large as 50% of the Setpoint. If this may do damage your process, reduce the Setpoint to 30-50% of its original value for the time of Auto-tune operation.

The time of Auto-tune operation can be between 0.1 to 3 hours, depending on the process. After reaching the Setpoint several times, the Auto-tune Mode will automatically stop and the AT indicator LED will go out.









The automatically set PID parameters can be read-out on the display (Parameter Table).

The UNICONT PM-300 can also operate with its default PID parameters.

Due to the probable several forced overshots, the technological process may be distorted during the Autotune Mode.

12. ERROR MESSAGES

In case of faulty setting or operation error code (Er) will appear on the SV display.

Error message	Description	Remark
Er 1	Set value(e.g. SV) is outside the measuring range	Er 1 will be on display for 3 seconds
Er 4	Configuration error	Acknowledge with  key
Er 5	Mains power failure	Acknowledge with  key
Er 6	Unauthorised setting of Setpoint See Submenu point “d.nni”	Acknowledge with  key
Er 7	Program is deleted: Re-programming is required	Acknowledge with  key
Er 10	Fault at the input, inverse connection	Acknowledge with  +  keys
Er 11	Connection to sensor is broken	Acknowledge with  +  keys

The error message Er 10 and Er 11 can also be acknowledged by switching off and on the power supply. Should the fault not be repaired, the error message will re-appear on the PV display after 2 minutes. Er11 will only be displayed in RUN Mode and with manual control enabled.

In case of other error messages contact the supplier.

13. PROCESS CONTROL TYPES

The UNICONT PM-300 supports the following control types

Constant value control

Follow-up control

Heating-cooling Control

Programmed-Control System

The UNICONT PM-300 is suitable for the special tasks

Motor Driven Valve Control

Manual Valve Control

Linearisation

Calculation of level difference

Constant value control

The Controller is keeping the Setpoint value, set on the SV display constant.

Follow-up control

The control is performed by keeping the Process variable (PV), received at In1., at the same value as the changing Setpoint value (SV), received at In2. As far as operation is concerned, the follow-up control is similar to the constant value control with remote value setting. The only difference is that the remote value will only be set time by time, while the SV (sent by an on site SV-transmitter, 0...20mA) of the follow-up control is changing.

Heating-cooling control

Heating-cooling control is an analogue control method for keeping the temperature at a set value by activating the cooler or heater respectively. To achieve this, one PID control loops and two outputs (relay or analogue) are provided. The PID parameter set is free programmable. During the process control the parameters may be changed over automatically.

A neutral (dead) zone of optional extent can be set both with relay or analogue output. Is the control signal within the neutral zone the output signal does not change. The neutral zone can be set in the Submenu point **P.dz**.

In process controls with relay output hysteresis can be dedicated to both relays. This hysteresis is symmetric and can be set at the Submenu point **d.HCh**, see **Figure 6**.

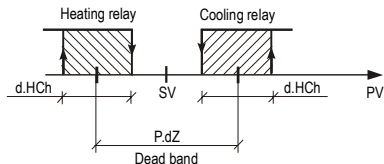

Figure 6.

Tasks, similar to cooling-heating can be solved with the controller, such as neutralisation of wastewater (titration).

Programmed Control

In case of Programmed Control, the SV will be reached with a ramp rate, set at Submenu point **S.rP**. The SV will be kept constant for the time, set at Submenu point **S.St**, and the control will be switched off.

If the SV cannot be reached because of an incorrect value entered, the controller will skip the ramp phase.

The ramp rate: unit of SV/h

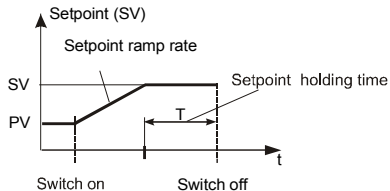

Figure 7.

After repeated power-up, the control will be continued from the actual process variable (PV)

- is the PV under the value of SV, the control will be continued with the same ramp rate. The Setpoint Holding Time will start at the time the Setpoint is reached.
 - is the PV of the same value as SV, the count down of the Setpoint holding time will continue from the point of interruption.
- The status of program can be indicated by alarm relays. (See Submenu point **d.AL***). The RAMP status will correspond to the "Ramp Phase" and the SOAK status to the "Setpoint Holding Phase".

Should the Setpoint be modified during the active control process, operation will be performed according to the setting of the Submenu point "**d.nni**": either the control will be switched off with error code "**Er6**" or the control will be performed in accordance with the new Setpoint. The timing will not change.

Motor Driven Valve Control

For the control of a motor driven valve the PID control loop is used with two relays: C1 for opening and C2 for closing the valve. The relay C2 operates in inverse mode: normally closed and open at the request for closing the valve. The C2 LED being "ON" indicate the closing of the valve.

For connecting the motor driven valve see figure below.

The "**dead band**", meeting the application requirements, can be set at the Submenu point "**P.dZ**".

Valve control can be performed with either ON-OFF or PID algorithm.

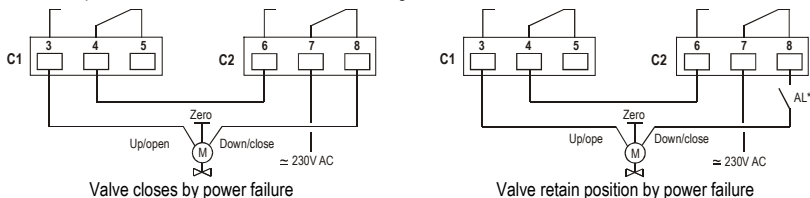

Figure 8.

There is no need for valve position feedback for the control. If the valve position signal is available, connect it to In2, and the valve position can be read on SV display.

The valve position signal on input In2 can only be read, it has no influence on the process variable (PV).

PID control of valves

The following parameters (amongst others) should be set:

d.Yt “Run Time” of valve. (Time needed for fully open the valve from fully closed status)

d.Yd Dead-Band of “Actuating Signal” of the valve (Y). (in % of the Run Time.)

In case of PID control the Actuating Signal will always change, even if the desired position is reached. The oscillation of the Actuating Signal can be up to 1-2%.

Without Dead Band the Actuating Signal would keep the valve in a continuous opening/closing motion. This usually does not improve the accuracy of the control, but decreases the lifetime of the valve dramatically.

To overcome this problem for example by setting **d.Yd** to 3%, the controller will operate the valve only if the change in “Actuating Signal” (Y) is bigger than 3%.

d.YL and **d.YH** These parameters are used as with the relay control mode.

P.dZ Determines the width of the input dead band that is symmetrical to SV. If the PV is within this band, there will be no “Error Signal”, therefore the PID controller is assuming that the correct Actuating Signal has been found.

The **d.Yd** and **P.dZ** values can only be optimised by several trials.

ON/OFF control of valve

For ON-OFF control, **P.P= 0** should be set. The hysteresis can be set at **P.dZ**. In this case the motor driven valve can only be in the two end-positions (fully open or fully closed) and the Actuating Signal is permanently applied to the valve.



Three-position control of valves

Choosing heating-cooling algorithm, setting the parameter **P.P=0** a three-position control will be achieved, where the neutral zone is set at the Submenu point **P.dZ** and the hysteresis of the switches at **d.HCh**.



Manual setting of motor driven valves

Motor driven valves with analogue input (0/4-20 mA) can also be remote controlled manually.

To switch over to Manual Mode, press the “Manual”  key for 5 seconds, the message “MAN” will be on the display and the valve control signal (Actuating Signal) will be displayed in percentage on the SV display.

To increase/decrease the valve control signal (Actuating Signal), press  and  keys respectively.

In case of failure, switching over to Manual Mode is carried out according to the setting of the parameter at the Submenu point **“d.Cnt”** (either holding last valid output control signal (Y) or with the parameter set at **d.YS**. Failure of the controller is

indicated by the alarm relay and the operator can manually control the process by changing the output control signal (Y) with  and  keys.

Calculation of level difference (differential level metering) or average

This function is valid only if the controller has two inputs (IN1 and IN2).

To use this function, proceed as follows:

- 1). Scale the IN1 and IN2 inputs at the Submenu **C.i1L** and **C.i1H**, as well as **C.i2L** and **C.i2H**.
- 2). Select a function (arithmetic function , subtraction, calculating average) at the Submenu **C.nAt**.

Linearisation

Linearisation will be needed if the relation between the measured value and the displayed value is not linear. This non-linear function can be approached by a series of data-pairs. This makes possible for instance to display the volume of the medium in a horizontal cylindrical tank by measuring the level.

The UNICONT PM-33_ and the PM-34_ can perform a linearisation of 32 data-pairs

To set the linearisation, proceed as follows:

Setting linearisation

- 1). Select the function of linearisation at the Submenu **C.uSr**
- 2). Scale the appropriate input(s) (IN1, IN2) at the Submenus **C.i1L** and **C.i1H** (**C.i2L** and **C.i2H**).
- 3). Select enabling linearisation and set modifiable analogue signal at Submenu-point **C.uSr**.
- 4). Enter data-pairs at the Submenu-point **I.t01** and **O.t01**

NOTE

The measured values and the values to be displayed have to be entered at the Submenu-point **I.txx** (in the measurement units of the input) and Submenu-point **O.txx** (in the measurement unit of the output) respectively. For example: should the value at the Submenu-point **I.t01** be 15 and the value at the Submenu-point **O.t01** be 18, this means that with the input signal reaching 15 the value of 18 will be displayed.

The 32 point-pairs can be entered in optional order with the constraint that increasing values of **I.txx** must come with increasing values of **O.txx**

14. DATA COMMUNICATION

The UNICONT PM-300 can be interconnected with other Controllers (such as computer or another PM-300) equipped with RS485 interface. The Controller uses MODBUS data communications protocol. For details see the “PI-MBUS-300 Rev B Gould Modbus Protocol Reference guide”

The UNICONT PM-300 supports both Serial Transmission Modes: RTU and ASCII.

Data bits	Protocol
7	MODBUS ASCII
8	MODBUS RTU

The data communication parameters can be set in the Submenu points **d.SEr** and **d.Adr** of the Menu point *Definition Table* “d.” (see section 8.2.).

The parameters of the data communication interface are configurable (bit rate, parity, 7/8 bit data).

Is the Controller address set to values between 1 and 254, it will operate as Slave.

Is an address set to ‘0’, the Controller is closed out from the communication

The UNICONT PM-300 is VISION 4 compatible.

Protocol functions:

04	Read input register	Reading of registers and MENU
06	Pre-set single register	Writing of registers and MENU
16	Pre-set multiple register	Writing of SV

Error messages:

01	Illegal function	Not used function code
02	Illegal data address	Not used address or register
03	Illegal data value	Incorrect value

Explanation of abbreviations used in the following tables:

Abbreviation	Description
B	Can be sent as a broadcast command
M	Accessible for multiple writing (function 10H) (the data always has two words)
R	Accessible for reading
W	Accessible for writing
2	Two word reading
bit	FF00= 1 or 0000= 0 (no other value is valid)
EDS	00 Where: = EDS
DP	The decimal points are according to address 0x980

The data communications are interpreted according to MODBUS default: HI byte is first, LOW byte is last in a single word (16 bit) data.

With two word data the controller follows the above procedure. First the most significant bit is transmitted followed by the less significant ones.

Addr.	Abbr.	Data	Description
0x100	B, M, R/W, 2	SV/10 (4 byte)	Setpoint*10 (tenfold value), SV is interpreted in 0.1 UNIT
0x140	R, 2	PV/10 (4 byte)	Process Variable (In1)/10 (the value is integer but interpreted in decimals)
0x142	R, 2	PV2/10 (4 byte)	Process Variable of In2 (interpreted as above)
0x146	R, 2	CJ/10 (4 byte)	Cold Junction Compensation value (interpreted as above)
0x200	R/W	SV	Setpoint (SP) seen on display, DP
0x210	R/W	Y/10	Actuating Signal (can be modified only in Manual Mode)
0x220	R	PV	Process Variable (PV) seen on display, DP
0x230	R	PV2	Secondary Process Variable (PV2) seen on display, DP
0x2FE	R		Type of controller ("Hi" byte), version number ("Lo" byte)
0x2FF	R		Error code (1 to 15) (least significant 4 bits of "Lo" byte)
0x800	B, R/W, bit		Start/stop On/Off control
0x801	R/W, bit		Control mode (Switching over between Manual and Automatic Mode)
0x802	R/W, bit		Enable/Disable of access to the controller
0x803	R/W, bit		Enable AT (Auto Tune)
0x804	R, bit		AT in progress
0x900	R		Relay status (Hi byte) and One-Shot status(Lo byte)
0xF00	W, bit		Reset Error
0xF01	W, bit		Reset "Alarm One-Shot"
0xF02	W, bit		Keyboard disable (the front panel keys are disabled for ~30sec)
0xFFF	W, bit		Restart controller

Addresses above 1000 are for the Menu points of the Controller.

For the accessibility the same rules apply as described with the Front panel functions (See page 22). (Functions and values inaccessible by front panel keys are also inaccessible over the serial interface) The ranges of values to be set via serial interface are also the same as those to be set by front panel keys.

Address	Abbr.	Data	Description
0x1000	R	S.PrG	Controller hardware versions and software version number
0x1001	R	S.in2	DP
0x1002	R	S.1-2	DP
0x1003	R	S.rP	
0x1004	R	S.St	
0x1005	R/W	S.A1	
0x1006	R/W	S.A2	
0x1007	R/W	S.A3	
0x1008	R/W	S.A4	
0x1009	R/W	S.Ah1	
0x100A	R/W	S.Ah2	
0x100B	R/W	S.Ah3	
0x100C	R/W	S.Ah4	
0x1100	R/W	P.P	
0x1101	R/W	P.I	
0x1102	R/W	P.d	
0x1103	R/W	P.nr	
0x1104	R/W	P.dZ	
0x1105	R/W	P.cG	
0x1106	R/W	P.2P	
0x1107	R/W	P.2I	
0x1108	R/W	P.2d	
0x1109	R/W	P.2nr	
0x1110	R/W	P.2dZ	
0x1111	R/W	P.2cG	
0x1200	R/W	d.PAS	0000...8192
0x1201	R/W	d.nni	EDS

Address	Abbr.	Data	Description
0x1202	R/W	d.Cnt	EDS
0x1203	R/W	d.Pid	EDS
0x1204	R/W	d.HSt	EDS
0x1205	R/W	d.AHS	EDS
0x1206	R/W	d.Ser	EDS
0x1207	R/W	dAL1	EDS
0x1208	R/W	dAL2	EDS
0x1209	R/W	dAL3	EDS
0x120A	R/W	dAL4	EDS
0x120B	R/W	AL1h	0...255 or 0.0...25.5 (depending on DP)
0x120C	R/W	AL2h	0...255 or 0.0...25.5 (depending on DP)
0x120D	R/W	AL3h	0...255 or 0.0...25.5 (depending on DP)
0x120E	R/W	AL4h	0...255 or 0.0...25.5 (depending on DP)
0x120F	R/W	d.Adr	0...255
0x1210	R/W	d. Yt	0...255
0x1211	R/W	d.cYt	0...255
0x1212	R/W	d.trA	0...100
0x1213	R/W	d. YS	0...100
0x1214	R/W	d. Yd	0...100
0x1215	R/W	d. YL	0...100
0x1216	R/W	d. YH	0...100
0x1217	R/W	d.cYL	0...100
0x1218	R/W	d.cYH	0...100
0x1219	R/W	d.HCH	0...100
0x1300	R/W	C.in1	EDS
0x1301	R/W	C.in2	EDS
0x1302	R/W	C.out	EDS

Address	Abbr.	Data	Description
0x1303	R/W	C.FLt	EDS
0x1304	R/W	C.nAt	EDS
0x1305	R/W	C.uSr	EDS
0x1306	R/W	C.Co1	-1999...+1999
0x1307	R/W	C.Co2	-1999...+1999
0x1308	R/W	C.Gn	-1999...+1999
0x1309	R/W	C.CGn	-1999...+1999
0x1310	R/W	C.OF1	-1999...+1999
0x1311	R/W	C.OFc	-1999...+1999
0x130A	R/W	C.OF2	-1999...+1999
0x130B	R/W	C.SuL	-1999...+9999 or -199.9...+999.9 (depending on DP)
0x130C	R/W	C.SuH	-1999...+9999 or -199.9...+999.9 (depending on DP)
0x130D	R/W	C.i1L	-1999...+9999
0x130E	R/W	C.i1H	-1999...+9999
0x130F	R/W	C.i2L	-1999...+9999
0x1310	R/W	C.i2H	-1999...+9999
0x1311	R/W	C.o1L	-1999...+9999 or -199.9...+999.9 (depending on DP)
0x1312	R/W	C.o1H	-1999...+9999 or -199.9...+999.9 (depending on DP)
0x1313	R/W	C.o2L	-1999...+9999 or -199.9...+999.9 (depending on DP)
0x1314	R/W	C.o2H	-1999...+9999 or -199.9...+999.9 (depending on DP)

To enable programming via the serial interface, when programming via front panel keys is disabled, send a Write command to address 0xF02 which will disable front panel keys for a period of 30 seconds. This can be extended by repeated the writing of this address. During this period the various protections can be enabled/disabled. For detailed information about enabling/disabling the access see Section 8.2.

The controller chooses the decimals concerning the PV, SV and the ALARMS according to the configuration.

15. EXAMPLES

EXAMPLE 1

Input: Temperature Sensor – Output:
ON-OFF relay

C. in1	Configuring the input and setting the places of the decimal points
C. SuL	Set lower limit of the measuring range
C. SuH	Set upper limit of the measuring range
d. Cnt	Selecting the type of control
d. Yt	Set cycle time (recommended: 15 sec.)
d.YL	Set min. pulse ratio within cycle time (recommended: 0%)
d.YH	Set max. pulse ratio within cycle time (recommended: 100%)
P.P	Select ON/OFF control mode (P=0)
P. dz	Set hysteresis value of ON/OFF control
SV1	Set the Setpoint
RUN	Start control process

EXAMPLE 2

Input: Temperature Sensor – Output:
PID relay

C. in1	Configuring the input and setting places of decimals
C. SuL	Entering the lower limit of measuring range
C. SuH	Entering the upper limit of measuring range
d. Cnt	Selecting the type of control
d. Yt	Entering the cycle time (recommended :15 sec.)
d.YL	Entering the min. pulse ratio within cycle time (recommended: 5%)
d.YH	Entering the max. pulse ratio within cycle time (recommended: 95%)
d.Pid	Entering the derivative filtering time and sampling rate
d.trA	Entering the value of first overshoot (recommended: 50%)
SV1	Entering the Setpoint
AT	Setting the PID parameters in Auto-tune Mode (AT)
RUN	Starting the control process

EXAMPLE 3

**Input: Analogue Signal – Output:
PID Analogue Control Signal**

C. in1	Configuring the input and setting places of decimals
C. SuL	Entering the lower limit of measuring range
C. SuH	Entering the upper limit of measuring range
C.i1L	Entering the value belonging to minimum input signal
C.i1H	Entering the value belonging to maximum input signal
C.FLt	Entering the input filtering time
C.out	Configuring the analogue output
C.o1L	Entering the value belonging to minimum output signal
C.o1H	Entering the value belonging to maximum output signal
d.Cnt	Selecting the type of control
d.YL	Entering the minimum of analogue output signal (recommended: 0%)
d.YH	Entering the maximum of analogue output signal (recommended: 100%)
d.Pid	Entering the derivative filtering time and sampling rate
d.trA	Entering the value of first overshoot (recommended: 50%)
SV1	Entering the Setpoint
AT	Setting the PID parameters in Auto-tune Mode (AT)
RUN	Starting the control process

EXAMPLE 4

**Input: Pt100 – Output PID relay with
programmed control algorithm**

C. in1	Configuring the input and setting places of decimals
C. SuL	Entering the lower limit of measuring range
C. SuH	Entering the upper limit of measuring range
d. Cnt	Selecting the type of control
d. Yt	Entering the cycle time (recommended: 15 sec.)
d.YL	Entering the min. pulse ratio within cycle time (recommended: 5%)
d.YH	Entering the max. pulse ratio within cycle time (recommended: 95%)
d.Pid	Entering the derivative filtering time and sampling rate
SV1	Entering the Setpoint
AT	Setting the PID parameters in Auto-tune Mode (AT)
S.rP	Setting the Ramp Rate
S.St	Setting the Setpoint Holding Time
RUN	Starting the control process

EXAMPLE 5

**Input: Temperature Sensor – Output:
PID relays for motor driven valve**

C. in1	Configuring the input and setting places of decimals
C. SuL	Entering the lower limit of measuring range
C. SuH	Entering the upper limit of measuring range
d. Cnt	Selecting the type of control
d. Yt	Entering the cycle time (is equal to the Run Time of Valve.)
d.YL	Entering the min. pulse ratio within cycle time (recommended: 5%)
d.YH	Entering the max. pulse ratio within cycle time (recommended: 95%)
d.Pid	Entering the derivative filtering time and sampling rate
P.dz	Entering the value of Dead Band
SV1	Entering the Setpoint
AT	Setting the PID parameters in Auto-tune Mode (AT)
RUN	Starting the control process

EXAMPLE 6

Setting the Alarms

d.AL*	Setting the operation mode of alarm relays
d.AHS	Setting the hysteresis type of alarm relays
d.Hst	Setting the first operation mode of alarm relays
S.A*	Setting the triggering value of alarm relays
S.A*h	Setting the hysteresis value of alarm relays

* Serial number of the alarm relays (AL1, AL2, AL3 and AL4), depending on the ordered configuration.

NIVETEC Distribuidora Autorizada: NIVETEC Instrumentação e Controle Ltda
Tel.:(11) 2627-6600 | comercial@nivetec.com.br | www.nivetec.com.br

pmm3111m0606p_01
March, 2001